

PLEASE CHECK WWW.MOLEX.COM FOR LATEST PART INFORMATION

Part Number: [0712510007](#)
Status: **Active**
Description: 1.27mm (.050") Pitch DIMM Socket, Vertical, Multiple Keys, Plastic Peg, 168 Circuits, 3.3V Standard DRAM

Documents:

[3D Model](#) [Product Specification PS-71243-9999 \(PDF\)](#)
[Drawing \(PDF\)](#) [RoHS Certificate of Compliance \(PDF\)](#)

Agency Certification

CSA LR19980
 UL E29179

General

Product Family Memory Module Sockets
 Series [71251](#)
 Comments Function Key Center, Voltage Key Center
 Component Type Memory Module
 JEDEC Outline MO-161
 Product Name DIMM

Physical

Circuits (Loaded) 168
 Circuits (maximum) 168
 Color - Resin Black, Natural
 Durability (mating cycles max) 25
 Entry Angle Vertical (Top Entry)
 Flammability 94V-0
 Function Key Center
 Keying to Mating Part Yes
 Material - Metal Phosphor Bronze
 Material - Plating Mating Gold
 Material - Plating Termination Tin
 Material - Resin High Temperature Thermoplastic
 PC Tail Length (in) 0.127 In
 PC Tail Length (mm) 3.23 mm
 PCB Locator Yes
 PCB Retention Yes
 PCB Thickness Recommended (in) 0.062 In
 PCB Thickness Recommended (mm) 1.57 mm
 Packaging Type Tray
 Pitch - Mating Interface (in) 0.050 In
 Pitch - Mating Interface (mm) 1.27 mm
 Pitch - Term. Interface (in) 0.050 In
 Pitch - Term. Interface (mm) 1.27 mm
 Plating min: Mating (µin) 2
 Plating min: Mating (µm) 0.05
 Plating min: Termination (µin) 150
 Plating min: Termination (µm) 3.81
 Temperature Range - Operating -40°C to +85°C
 Termination Interface: Style Through Hole

Electrical

Current - Maximum per Contact 1A
 Voltage - Maximum 100V AC (RMS)/DC
 Voltage Key Center

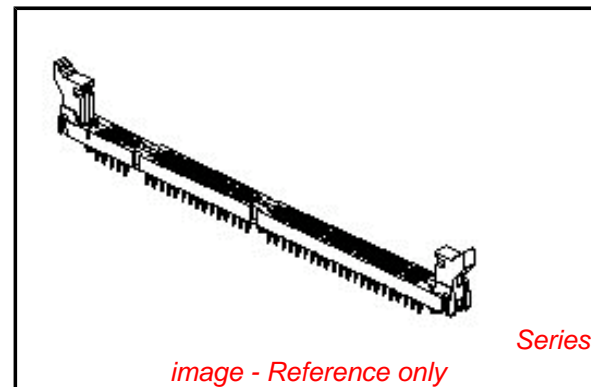

EU RoHS

ELV and RoHS Compliant
REACH SVHC
 Not Reviewed
Halogen-Free Status
Not Reviewed

China RoHS



Need more information on product environmental compliance?

Email productcompliance@molex.com
 For a multiple part number RoHS Certificate of Compliance, [click here](#)

Please visit the [Contact Us](#) section for any non-product compliance questions.

Search Parts in this Series

[71251Series](#)

Mates With

JEDEC MO-161 modules

Solder Process Data

Lead-free Process Capability

Wave Capable (TH only)

Material Info**Reference - Drawing Numbers**

Product Specification

PS-71243-9999

Sales Drawing

SDA-71251-0***

This document was generated on 04/13/2010

PLEASE CHECK WWW.MOLEX.COM FOR LATEST PART INFORMATION

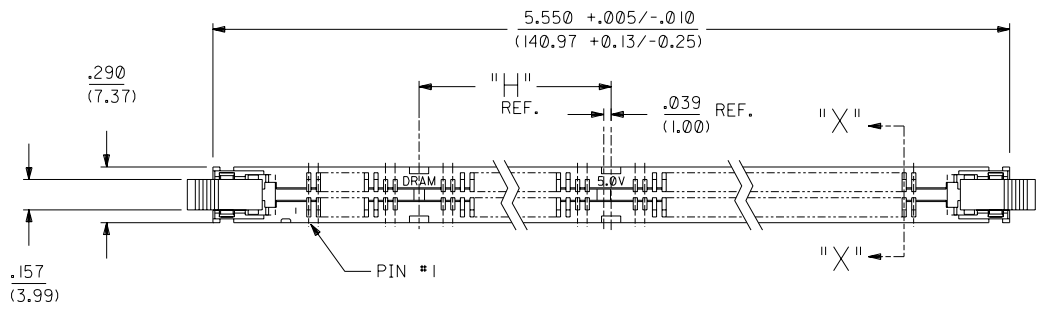

- NOTES:
- CARD SLOT ACCEPTS $.050 \pm .004$ (1.27 ± 0.10) MODULE THICKNESS. (MEASURED OVER P.C. PADS).
 - ALL PEGS ARE INTERFERENCE FITS TO PCB UNLESS NOTED ON THE DWG.
 - REFER TO PRODUCT SPEC PS-71243-9999 FOR PERFORMANCE SPECIFICATIONS.
 - PRODUCT IS PACKAGED IN TRAYS.
 - RECOMMENDED MODULE LAYOUT SHALL BE PER JEDEC MO-161.
 - RECOMMENDED PLATING ON MODULE PADS: 30 MICROINCH/(0.76 MICROMETER) MINIMUM HARD GOLD (Au) OVER 79 MICROINCH/(2.0 MICROMETER) MINIMUM NICKEL (Ni).
 - SEE CHART FOR HOLE SIZE AND PRESENCE AND PLATING OPTION.
 - PRODUCT WILL HAVE DATE CODE STAMPED ON SIDE OF HOUSING.

MATERIALS:
 HOUSING - GLASS FILLED LIQUID CRYSTAL POLYMER (LCP), UL 94V-0, COLOR: BLACK.
 TERMINAL - PHOSPHOR BRONZE
 LATCHES - GLASS FILLED HIGH TEMPERATURE NYLON, UL 94V-0, COLOR: IVORY.

PLATING:
 CONTACT AREA: OPTION A: GOLD (Au) FLASH; THICKNESS=2-10 MICROINCH/(0.05-0.25 (0.05-0.25 MICROMETER), OVER PALLADIUM-NICKEL (Pd-Ni); THICKNESS=30 MICROINCH/(0.76 MICROMETER) MINIMUM.
 OPTION B: GOLD (Au) FLASH; THICKNESS=2-10 MICROINCH/(0.05-0.25 MICROMETER), OVER PALLADIUM-NICKEL (Pd-Ni); THICKNESS=20 MICROINCH/(0.51 MICROMETER) MINIMUM.

SOLDER TAILS: TIN (Sn); THICKNESS=150 MICROINCH/(3.81 MICROMETER) MINIMUM.
 UNDERPLATE: NICKEL (Ni) OVER ENTIRE CONTACT.

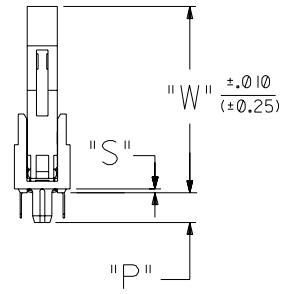

NOTE FOR LEAD FREE CONVERSION:
 THE PRIMARY SHIPPING CARTON WILL BE LABELED "COMPLIANT TO RoHS DIRECTIVE 2002/95/EC AND ELV ANNEX II OF DIRECTIVE 2000/53/EC". CARTONS WITHOUT THIS LABEL MAY CONTAIN PRODUCT WITH LEAD.

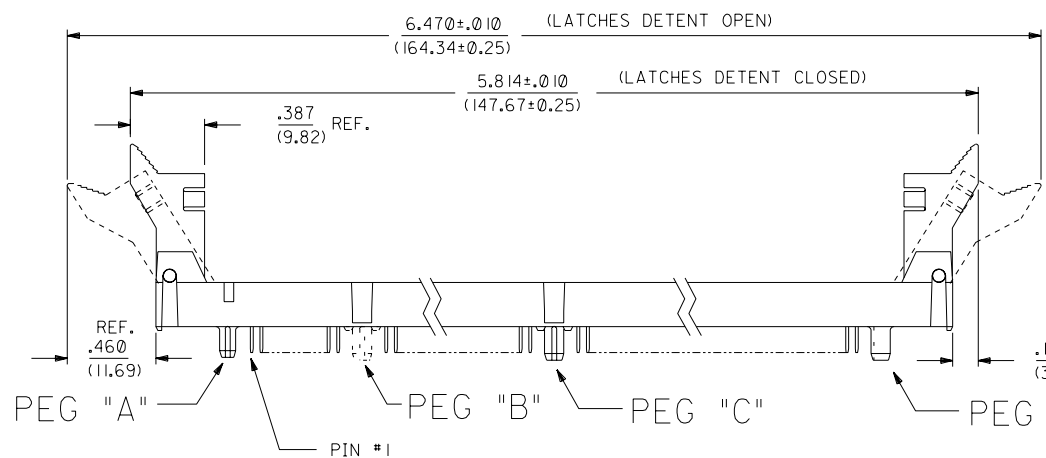

71251-0004 SHOWN

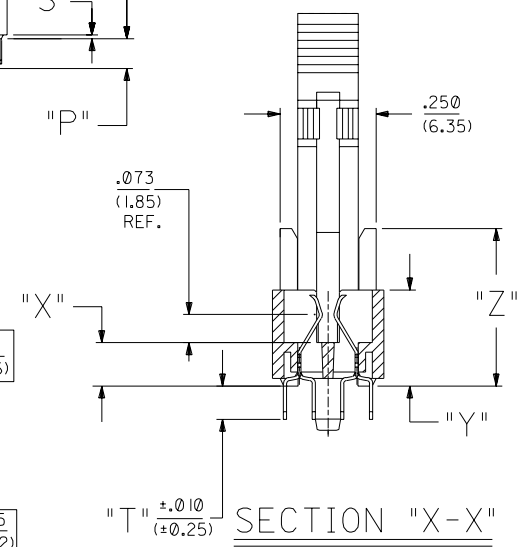
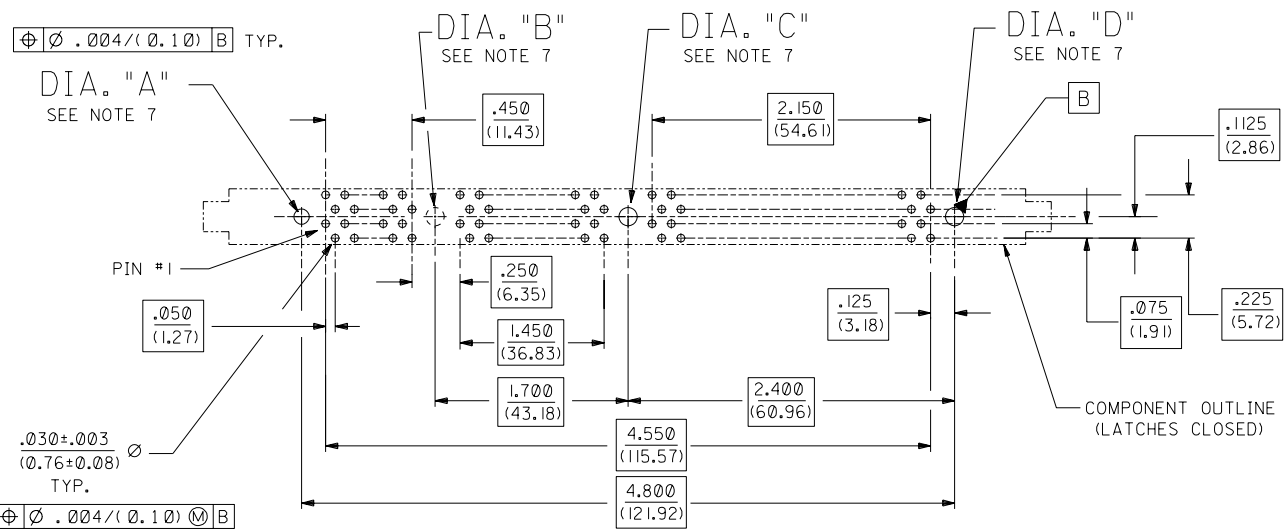

H1	ADD LEAD FREE NOTE ECR# UC2004-1732 DMORGAN 04/03/09
H	RELEASE -0027 ECR# UD2000-1151 DMORGAN 00/05/19
H	RELEASE -0027 ECR# UD2000-1151 DMORGAN 00/05/19
G	CHG Sn-Pb THICKNESS ECR# UD1999-0454 DMORGAN 99/08/09
F3	REVISED PER ECR# U80435 97-8-8 LAURX
F2	REVISED PER ECR# U71162 97-4-15 LAURX
F1	REVISED PER ECR# U70361 96-10-9 LAURX
F	REVISED PER ECR# U61133 96-9-25 LAURX
E1	REVISED PER ECR# U60836 1-19-96 JCL
E	REVISED PER ECR# U60682 12-7-95 JCL
D2	REVISED PER ECR# U60452 10-10-95 JCL
D1	REVISED PER ECR# U60361 9-18-95 JCL
D	REVISED PER ECR# U51288 8-4-95 JCL

DIMENSIONS SHOWN (METRIC) INCH UNLESS OTHERWISE SPECIFIED TOLERANCES: ANGULAR $\pm 1/2^\circ$		REVISE ONLY ON CAD SYSTEM	
3 PLAGE $\pm .005$	INCH	TITLE	
2 PLAGE $\pm \dots \pm 0.13$	METRIC	.050/(1.27) PITCH MULTI-KEY	
1 PLAGE $\dots \pm 0.25$		168 CKT DIMM RAM ASSY	
DRAFT WHERE APPLICABLE MUST REMAIN WITHIN DIMENSIONS		17.8mm LATCH SALES DWG	
DRWG. BY DCB	CHK'D BY DCB	FILE NAME	SHEET NO. DATE
APP'D BY DCB	SCALE 2:1	ST125101 DGN	1 OF 3 10/10/94
PART NO. DRWG. NO.		THIS DRAWING CONTAINS INFORMATION THAT IS PROPRIETARY TO MOLEX INC. AND SHOULD NOT BE USED WITHOUT WRITTEN PERMISSION	
SEE CHART		SDA-71251-0***	

RECOMMENDED P.C. BOARD HOLE PATTERN (CONNECTOR SIDE)

PART NUMBER	COLOR	DESCRIPTION	FUNCTION KEY	VOLTAGE KEY	DIA. "A"	DIA. "B"	DIA. "C"	DIA. "D"	DIM. "H"	DIM. "P"	DIM. "S"	DIM. "T"	DIM. "W"	DIM. "X"	DIM. "Y"	DIM. "Z"	CONTACT AREA PLATING
71251-0001	BLACK	3.3 VOLT STD DRAM	CENTER	CENTER	.080±.002 (2.03±0.05)	NONE	.093 +.003/-0.000 (2.36+0.08/-0.00)	.093 +.003/-0.000 (2.36+0.08/-0.00)	1.700 (43.18)	.155 (3.94)	.020 (0.51)	.127 (3.23)	.970 (24.64)	.113 (2.87)	.250 (6.35)	.410 (10.41)	OPTION A
71251-0004	BLACK	5.0 VOLT STD DRAM	CENTER	OFFSET LEFT	.080±.002 (2.03±0.05)	NONE	.093 +.003/-0.000 (2.36+0.08/-0.00)	.093 +.003/-0.000 (2.36+0.08/-0.00)	1.700 (43.18)	.155 (3.94)	.020 (0.51)	.127 (3.23)	.970 (24.64)	.113 (2.87)	.250 (6.35)	.410 (10.41)	OPTION A
71251-0012	BLACK	3.3 VOLT UNBUFFERED	OFFSET RIGHT	CENTER	.080±.002 (2.03±0.05)	NONE	.093 +.003/-0.000 (2.36+0.08/-0.00)	.093 +.003/-0.000 (2.36+0.08/-0.00)	1.661 (42.19)	.155 (3.94)	.020 (0.51)	.127 (3.23)	.970 (24.64)	.113 (2.87)	.250 (6.35)	.410 (10.41)	OPTION A
71251-0013	BLACK	5.0 VOLT UNBUFFERED	OFFSET RIGHT	OFFSET LEFT	.080±.002 (2.03±0.05)	NONE	.093 +.003/-0.000 (2.36+0.08/-0.00)	.093 +.003/-0.000 (2.36+0.08/-0.00)	1.661 (42.19)	.155 (3.94)	.020 (0.51)	.127 (3.23)	.970 (24.64)	.113 (2.87)	.250 (6.35)	.410 (10.41)	OPTION A
71251-0016	BLACK	3.3 VOLT SYNCHRONOUS	OFFSET LEFT	CENTER	.080±.002 (2.03±0.05)	NONE	.093 +.003/-0.000 (2.36+0.08/-0.00)	.093 +.003/-0.000 (2.36+0.08/-0.00)	1.739 (44.17)	.155 (3.94)	.020 (0.51)	.127 (3.23)	.970 (24.64)	.113 (2.87)	.250 (6.35)	.410 (10.41)	OPTION A
71251-0017	BLACK	5.0 VOLT SYNCHRONOUS	OFFSET LEFT	OFFSET LEFT	.080±.002 (2.03±0.05)	NONE	.093 +.003/-0.000 (2.36+0.08/-0.00)	.093 +.003/-0.000 (2.36+0.08/-0.00)	1.739 (44.17)	.155 (3.94)	.020 (0.51)	.127 (3.23)	.970 (24.64)	.113 (2.87)	.250 (6.35)	.410 (10.41)	OPTION A

NOTES:

1. STRAIGHTNESS OF MODULE APPLIES TO THE AREA FROM THE BOTTOM OF THE CARD UP .157/(4.00).
2. IF TIE BARS ARE ATTACHED TO PADS, THE TIE BAR SHOULD BE ON AN INTERNAL LAYER, SO THAT THE REMNANT CANNOT CAUSE DAMAGE TO THE CONTACTS.

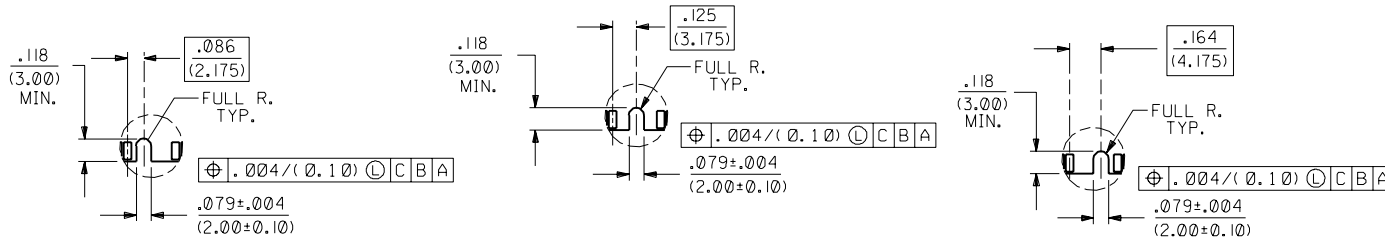

OFFSET LEFT KEY

CENTERED KEY

OFFSET RIGHT KEY

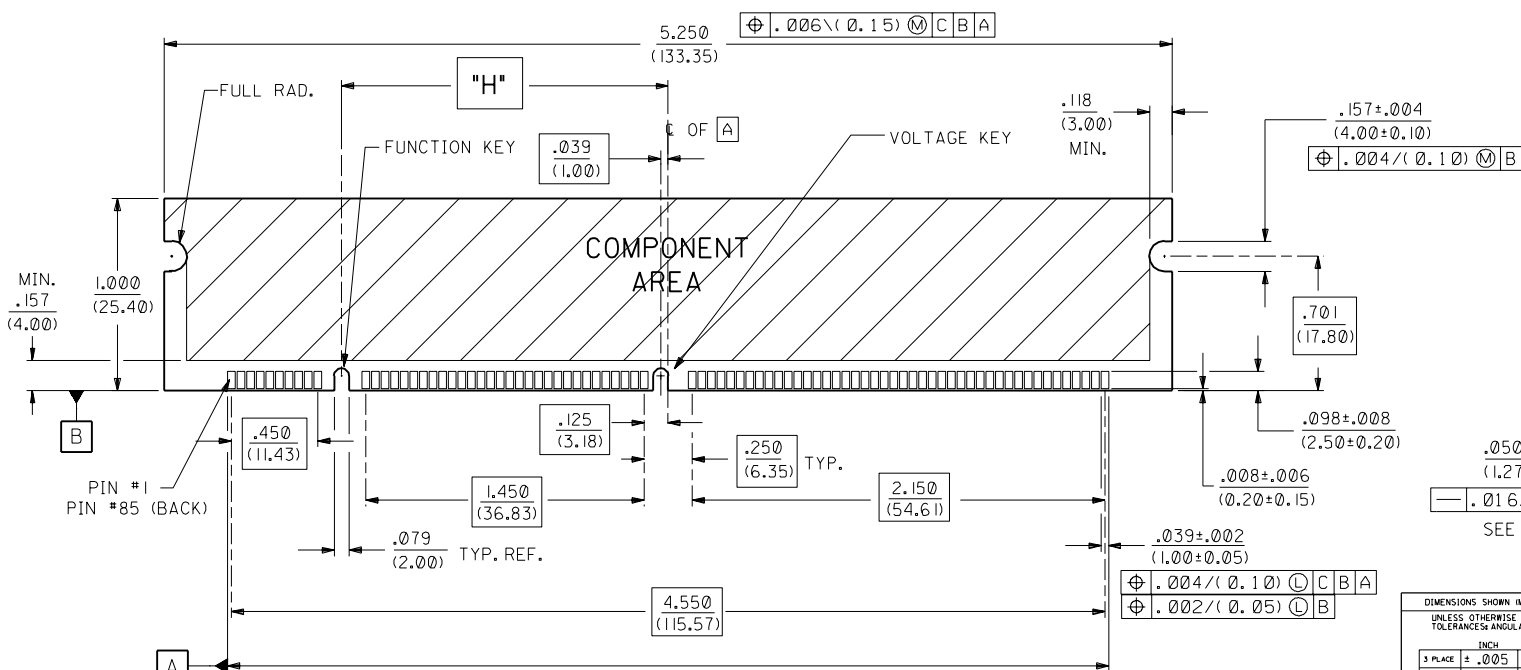

RECOMMENDED MODULE LAYOUT
168 CKT 5.0V DRAM SHOWN

F3	SEE SHEET I
F2	SEE SHEET I
F1	SEE SHEET I
F	SEE SHEET I
E1	SEE SHEET I
E	SEE SHEET I
D2	SEE SHEET I
D1	SEE SHEET I
D	SEE SHEET I
C	SEE SHEET I
B1	SEE SHEET I
B	SEE SHEET I
A	SEE SHEET I

DIMENSIONS SHOWN (METRIC) INCH UNLESS OTHERWISE SPECIFIED TOLERANCES ANGULAR ± 1/2°		TITLE .050/(1.27) PITCH MULTI-KEY 168 CKT DIMM RAM ASSY 17.8mm LATCH SALES DWG.	
3 PLACE ± .005	INCH	DATE	10/10/94
2 PLACE ± .01	METRIC	SHEET NO.	2
1 PLACE --- ± 0.25		MOLEX INCORPORATED	
DRAFT WHERE APPLICABLE MUST REMAIN WITHIN DIMENSIONS		L1SLEJLL 60532 U.S.A.	
DRWG. NO.	DCB	CHK'D. BY	DCB
FILE NAME	SEE CHART	DRWG. NO.	SDA-71251-0...
APP'D. BY	DCB	SCALE	2: 1
THIS DRAWING CONTAINS INFORMATION THAT IS PROPRIETARY TO MOLEX INC. AND SHOULD NOT BE USED WITHOUT WRITTEN PERMISSION.		DIV.	CP

